



CE ISO 9001

D800H SOFT SERVE MACHINE

The D800H is the premier soft serve machine for all dessert concepts. The D800H includes our novel hopper mixing system that allows the user to adjust the hopper mixing time to prevent over agitation of the product in the hoppers. The D800H also offers independently adjustable digital hopper temperature controls through a simple, user-friendly, interface that greatly reduces the complexities of being a machine operator. The D800H runs consistently throughout the day, offering customers a smooth and creamy product with every serving.

Features

- Self contained air cooled countertop
- Two flavor with twist
- Serves frozen yogurt, sorbet, custard, soft serve ice cream, and gelato
- Fast 7-10 min* to first dispense frozen product
- Digital consistency, hopper mixing, and hopper cooling controls for easy operation
- Standby mode maintains fresh product overnight and reduces daily product drain and cleans.
- Refrigerated hoppers with automatic mixers to maintain fresh product overnight and prevent product separation

DONPER USA

Donper USA
24610 Kingsland Blvd
Katy, TX 77494

1-844-366-7371
sales@donperusa.com
www.donperusa.com

D800H

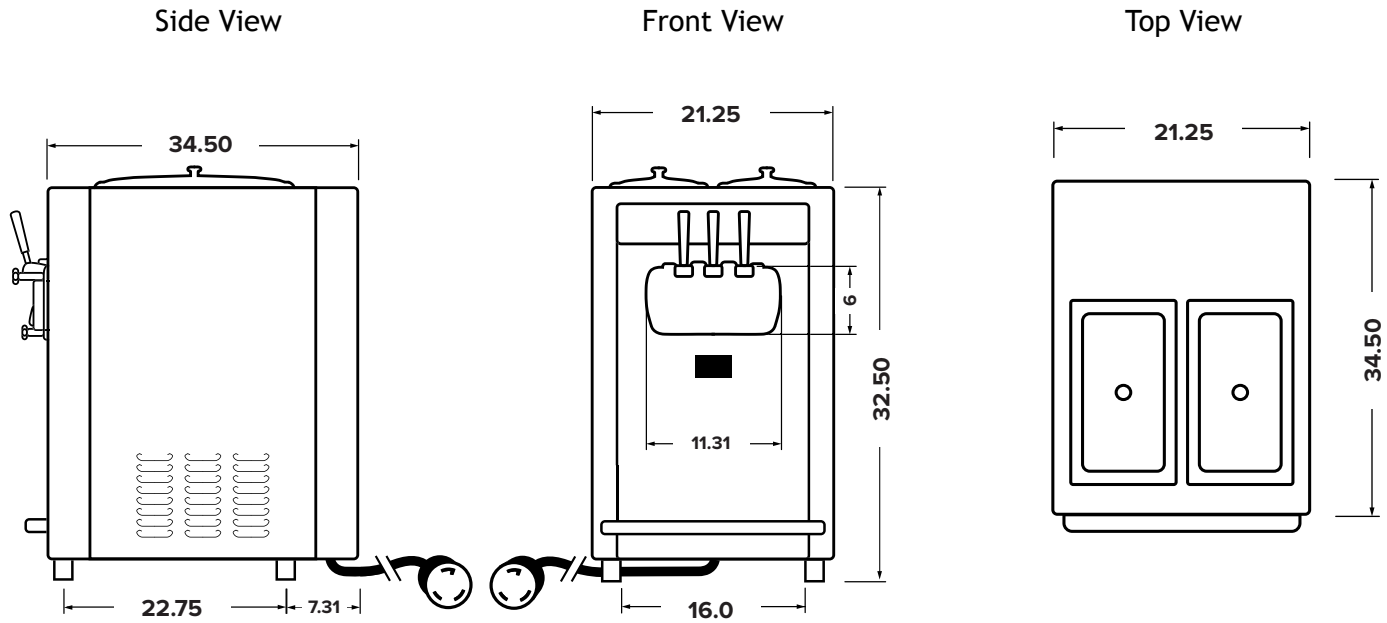

Measurements in inches.

Size and Capacity

Freezing Cylinders (each)	2 Qt (1.9 L)
Refrigerated Hoppers (each)	9.5 Qt (9 L)
Appx. Hourly Production	46-59 Qt (44-56 L)
Height	32.5 in (826 mm)
Width	21.3 in (540 mm)
Depth	34.5 in (876 mm)
Weight	352 lbs (160 kg)

Electrical

Voltage	230 v
Phase	Single
Rated Input Power	30A (4.6 kW)
Breaker Size	30A, Double Pole
Main Compressor	2 HP (R404A)
Hopper Cooling Compressor	1/6 HP (R134A)
Drive Motors (each)	1 HP (750W)
Hertz	60 Hz
Plug type	NEMA L6-30P

Distributed By:

DONPER USA

Donper USA
24610 Kingsland Blvd
Katy, TX 77494

1-844-366-7371
sales@donperusa.com
www.donperusa.com